

Spirit200a MICROPROCESSOR PCB

KALIBURN		
SCALE: NONE	APPROVED BY:	DRAWN BY: JTH
DATE: 1/21/08		REVISION: F
Spirit200a SYSTEM SCHEMATIC (208V THREE PHASE SHOWN)		
TOLERANCE: .XX .XXX .ANGLE	DRAWING NUMBER: D282410	

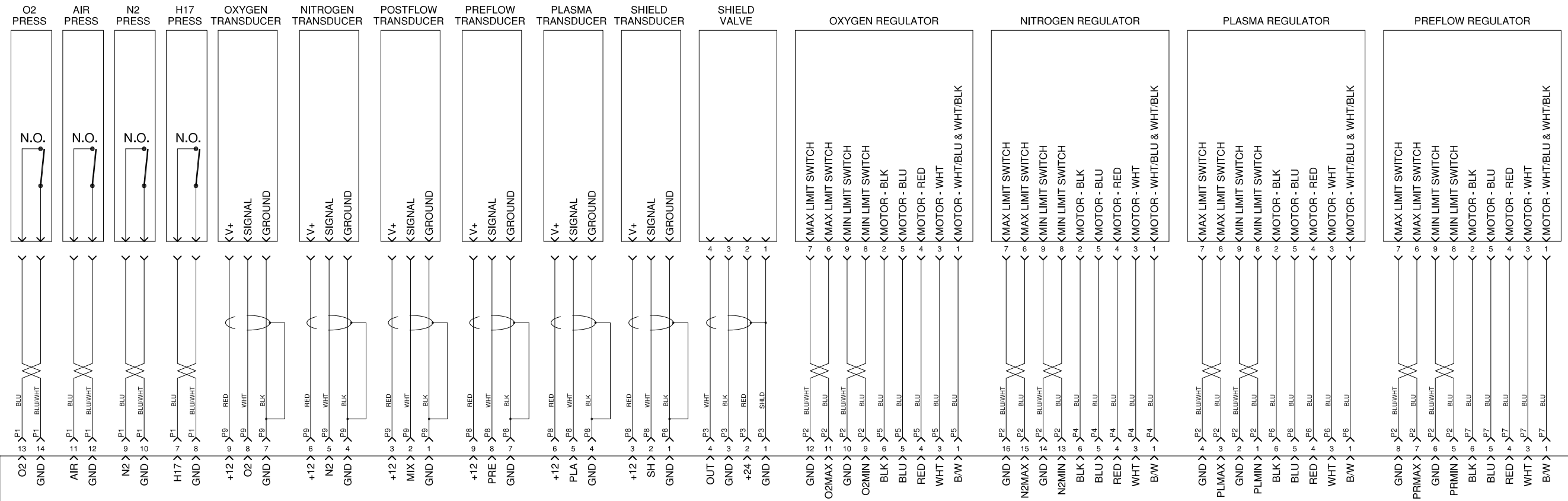

AGC I/O PC BOARD

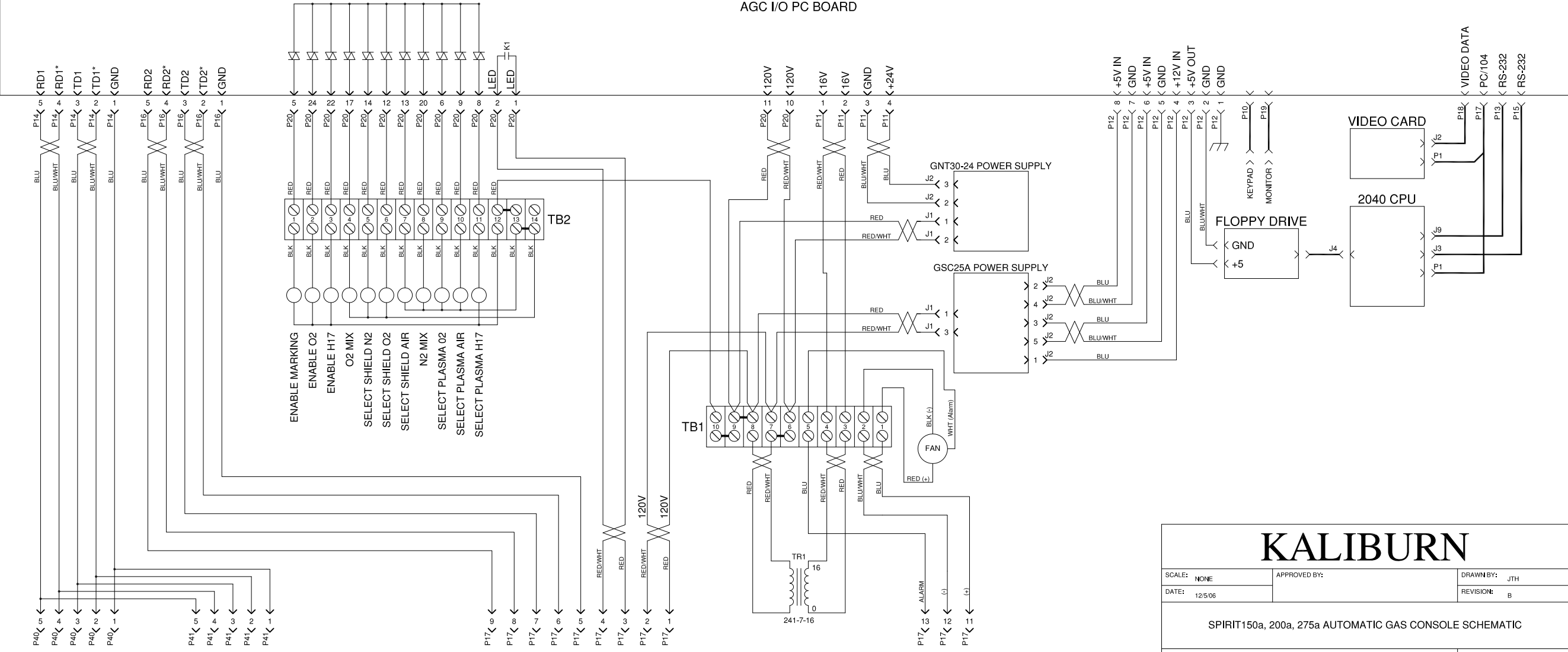

KALIBURN

SCALE: NONE	APPROVED BY:	DRAWN BY: JTH
DATE: 12/5/06		REVISION: B
SPIRIT150a, 200a, 275a AUTOMATIC GAS CONSOLE SCHEMATIC		
TOLERANCE: .XX .XXX ANGLE	DRAWING NUMBER: D280002	